

Sonniboy Mercedes E-Klasse W212 4-door, Heckscheibe, Tür hinten  
 0078259AC  
 2009 →

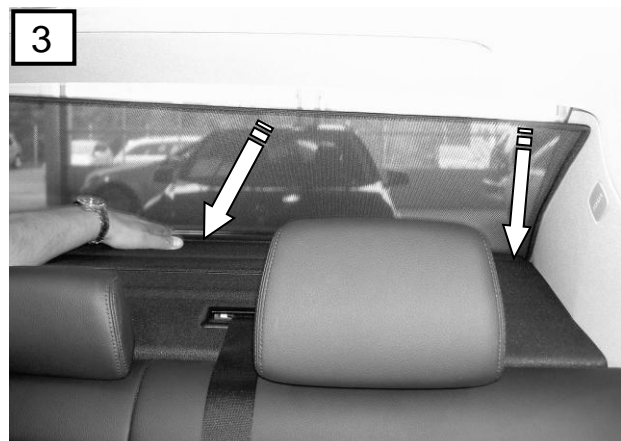

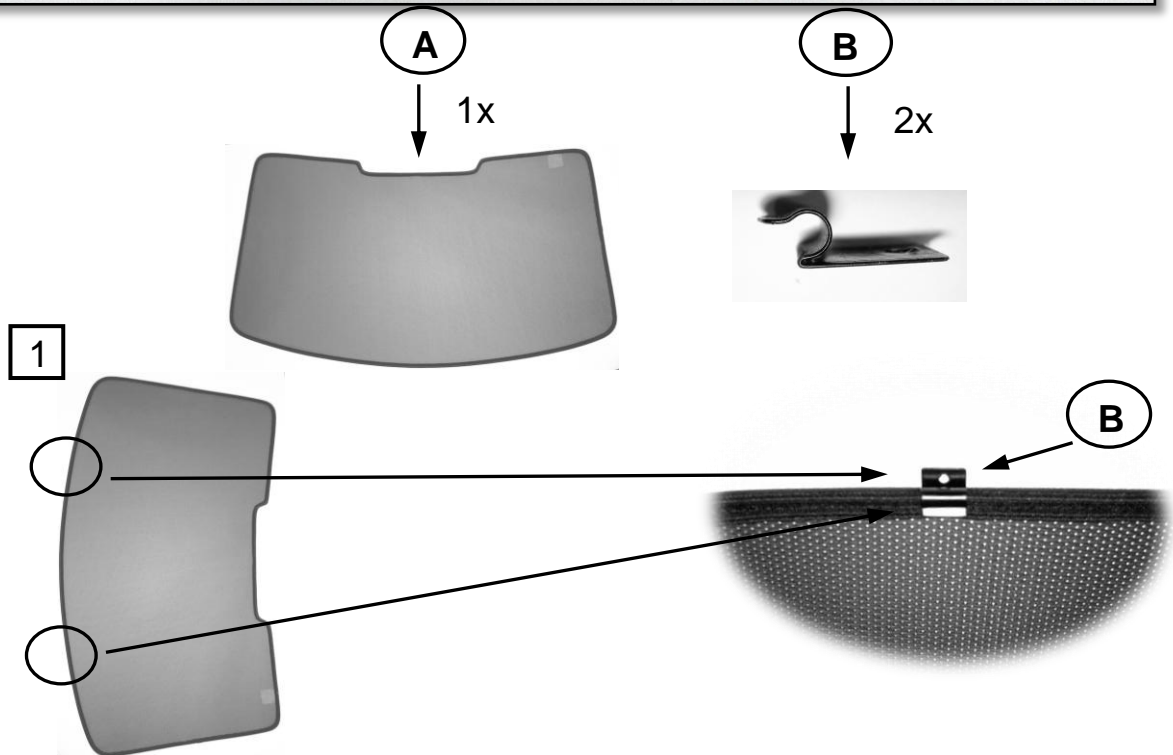
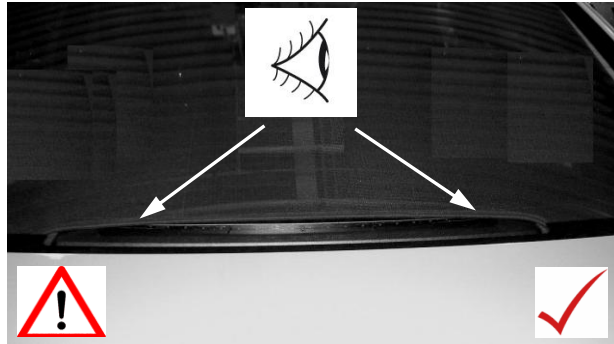
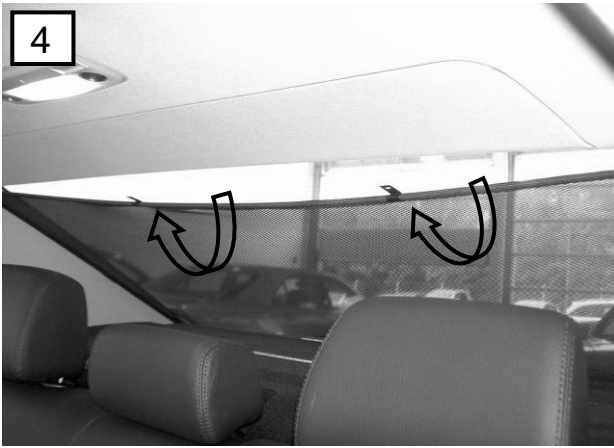

**C**

2x (Left & Right)

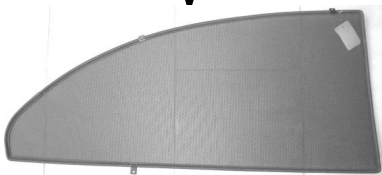

**B**

2x



**D**

6x



**E**

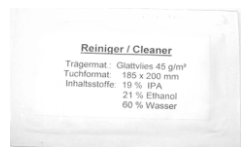

**6**

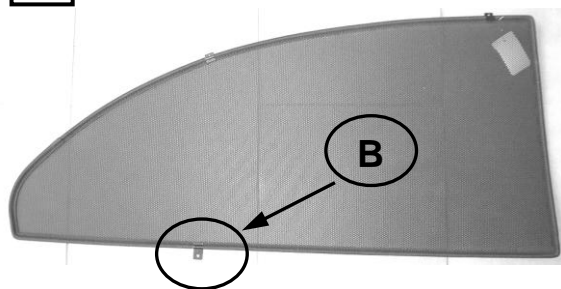

**7**

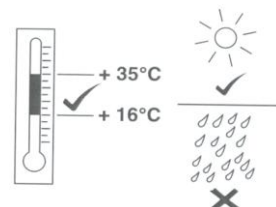
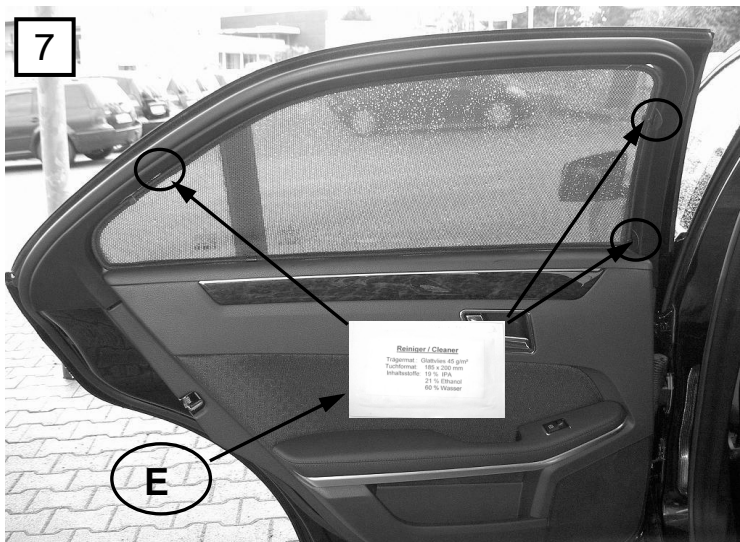

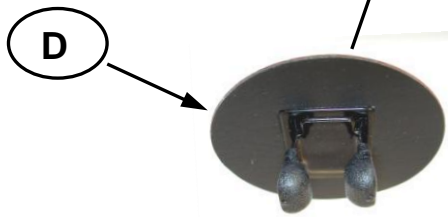

left door 1x  
right door 1x

10



9

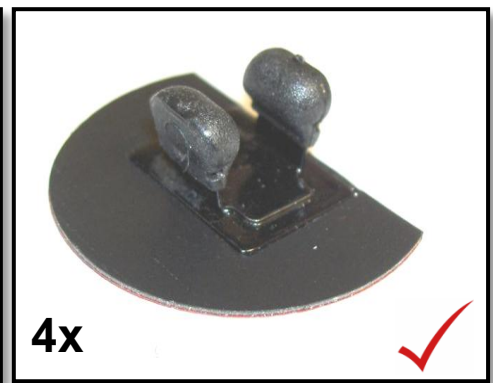
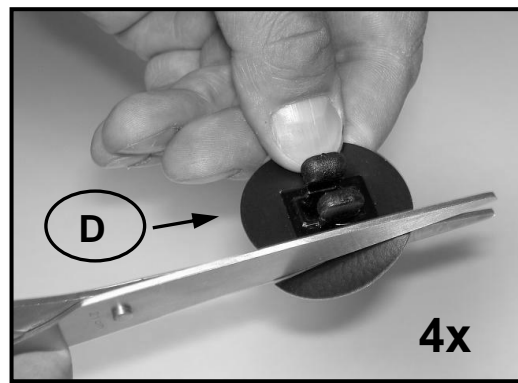

10

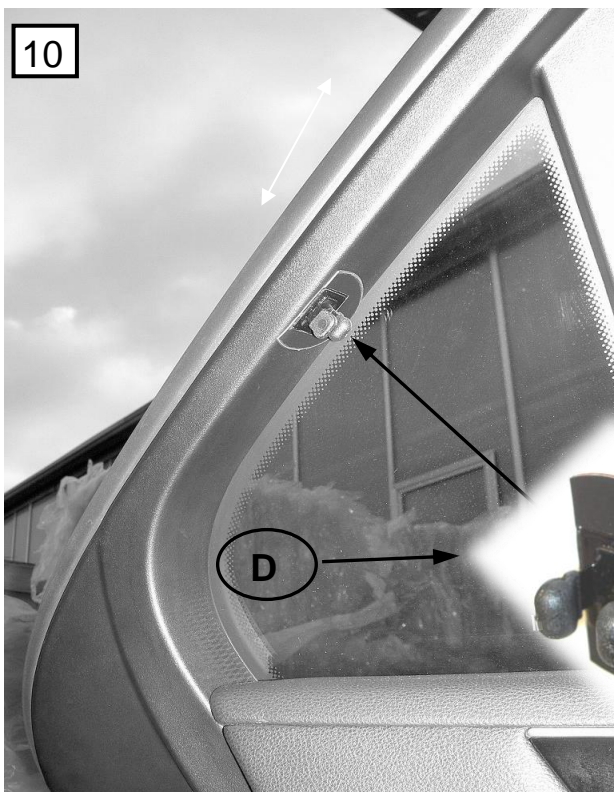

11

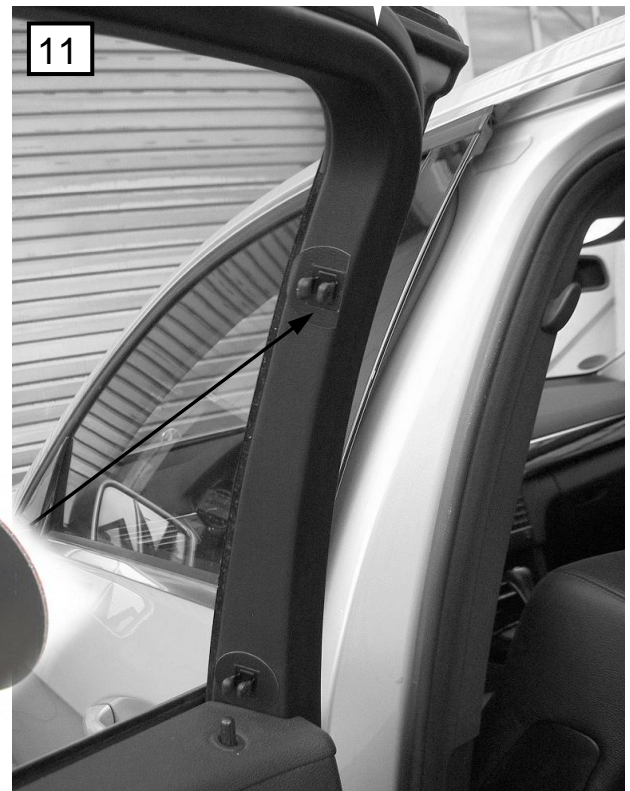

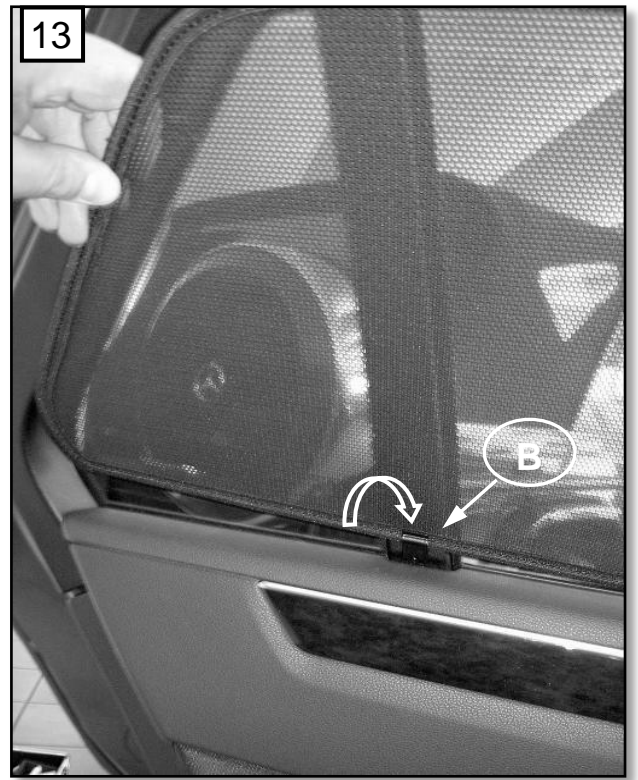
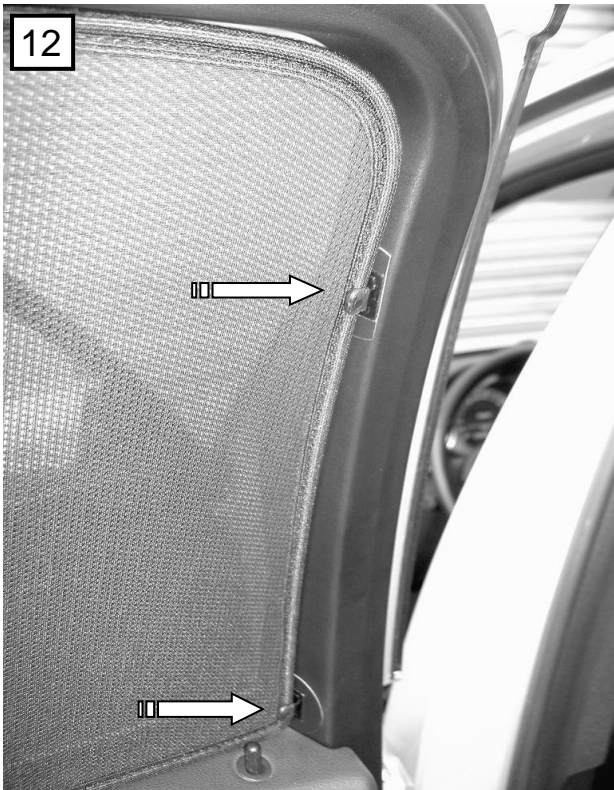

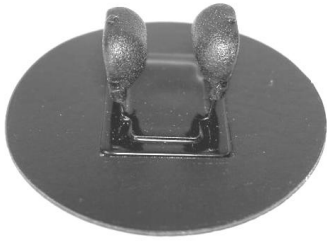

## Hinweise zur Vermeidung von Fehlern beim Kleben

### **Recommendations for the prevention of errors during gluing**

- Die zu verklebenden Oberflächen müssen sauber, trocken, fett- und staubfrei sein  
*The surfaces must be clean, dry, grease- and dust free*
- Silikonhaltiges Cockpitspray ist unbedingt zu vermeiden  
*Cockpit spray which contains silicone has absolutely to be avoided*
- Nach dem Reinigen mit dem Reinigungstuch darf erst nach vollständigen Abtrocknen verklebt werden  
*To be used only after complete drying and cleaning with cleaning cloth*
- Die Oberflächentemperatur der Klebefläche soll während des Aushärtezeitraums (24 bis 48 Stunden) nicht unterhalb von 16°C und oberhalb von 35°C liegen. Direkte Sonneneinstrahlung ist im Aushärtezeitraum zu vermeiden  
*The surface temperature of the adhesive surface during curing time (24 to 48 hours) should not be below 16°C and not over 35°C. Direct sunlight should be avoided during curing time*

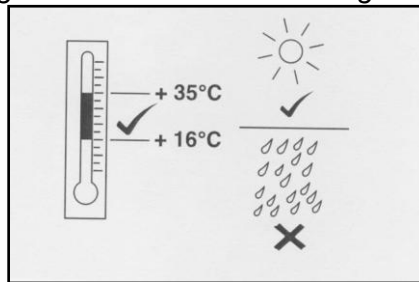

- Der Klebehalter sollte beim Ankleben mindestens 30 Sekunden fest angedrückt werden  
*The adhesive holders should be pressed firmly for 30 seconds during gluing.*
- Die vollständige Klebekraft wird erst nach 48 Stunden erreicht  
*Full adhesion is reached after 48 hours only*
- Der Sonnenschutz darf erst nach Erreichen der vollständigen Klebekraft eingebaut werden und muss spannungsfrei zwischen den Clips fixiert sein  
*The Sonniboy has to be installed only after reaching the full bond strength and has to be fixed without tension between the clips*

